

is informed by

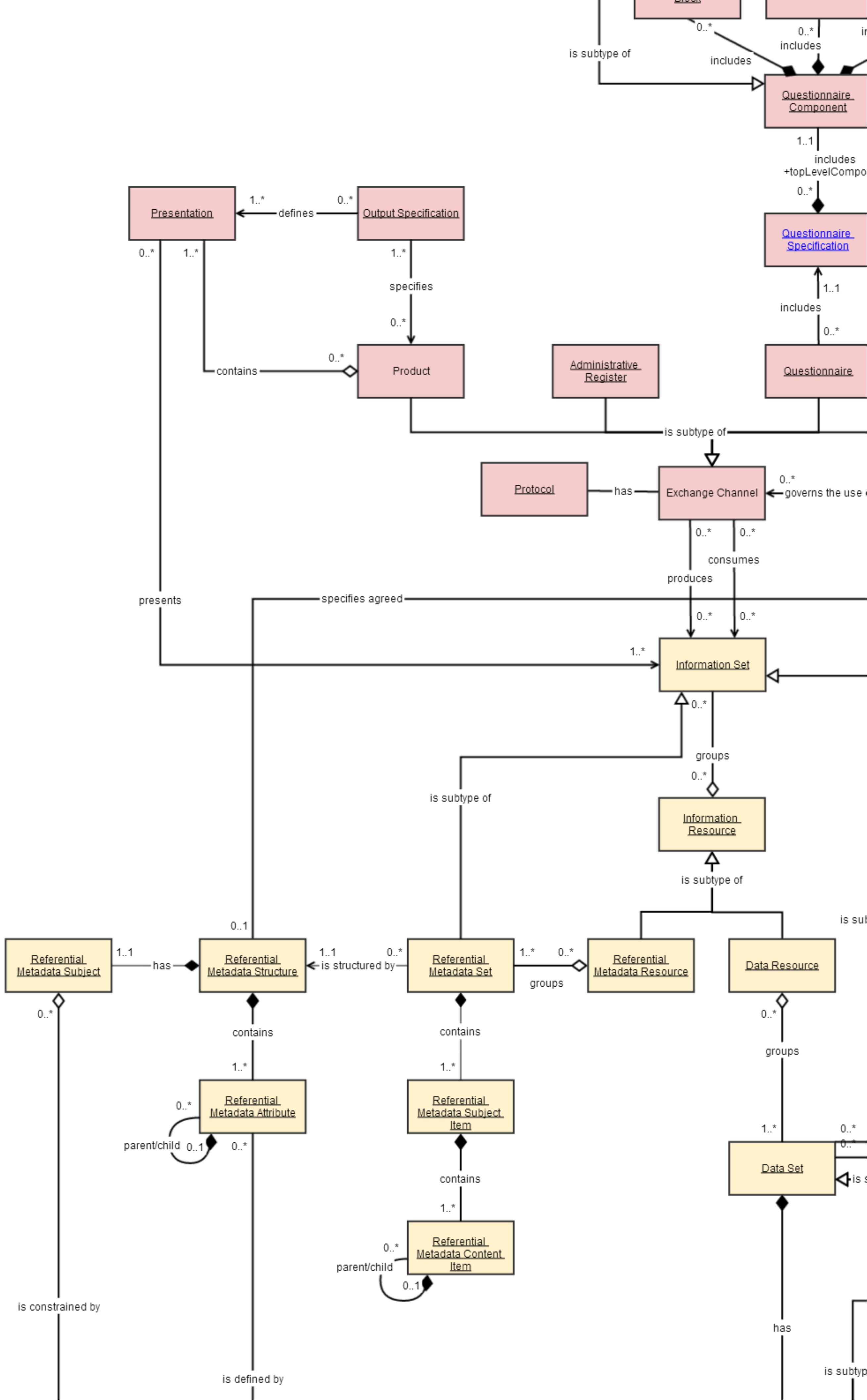

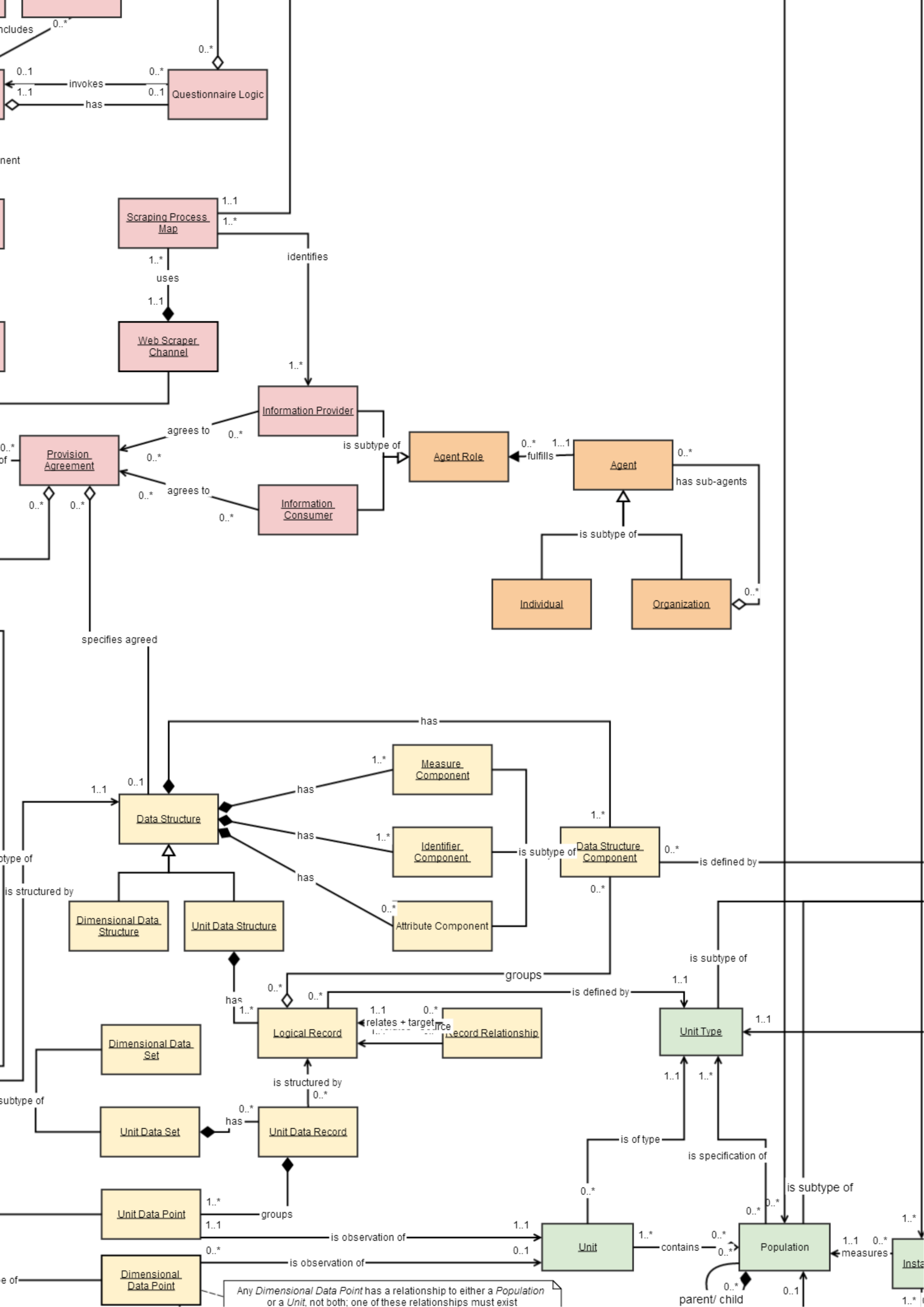

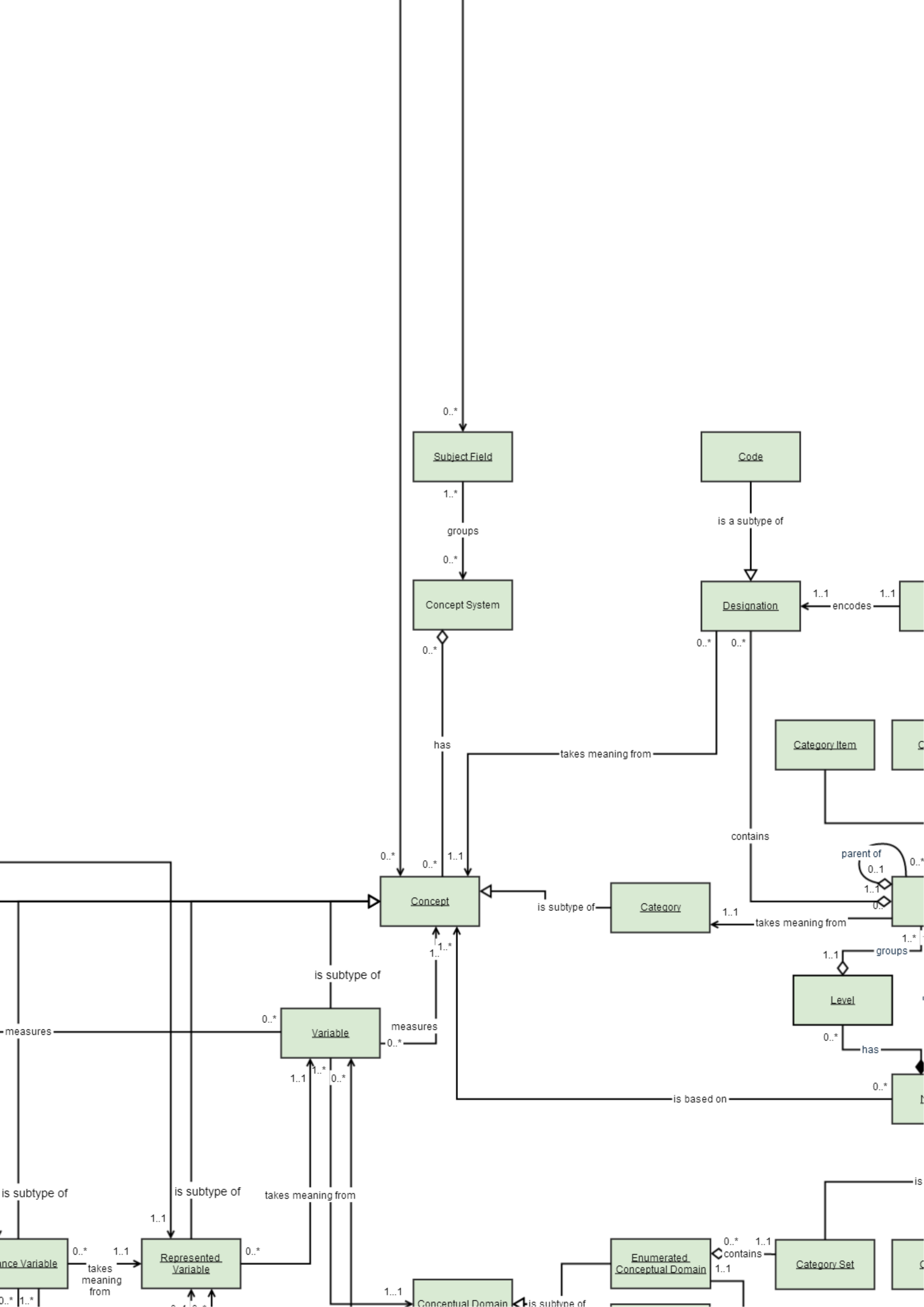



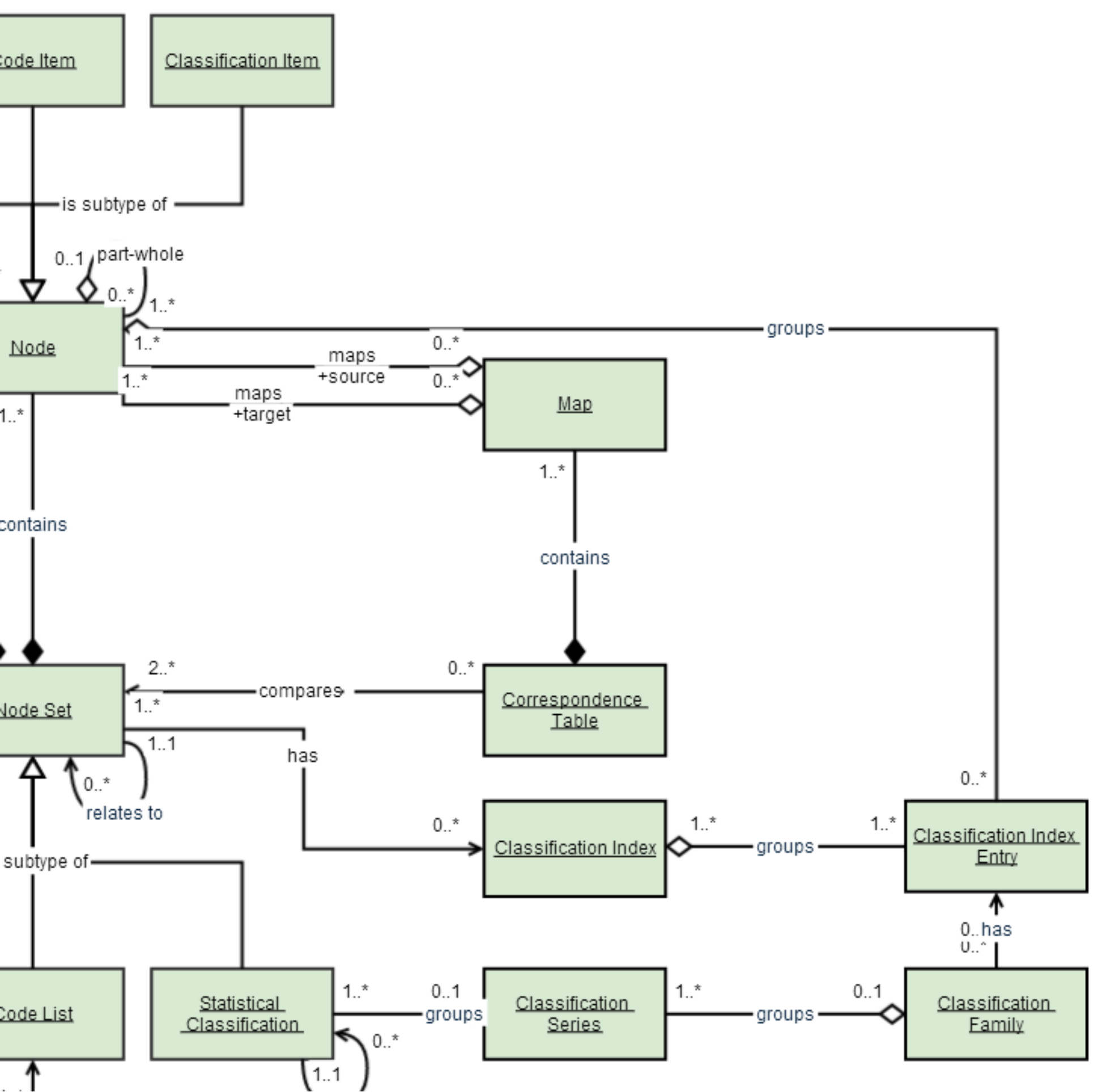
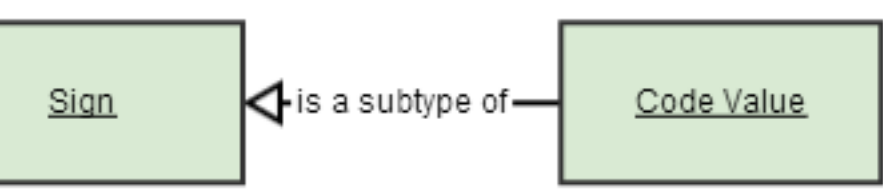



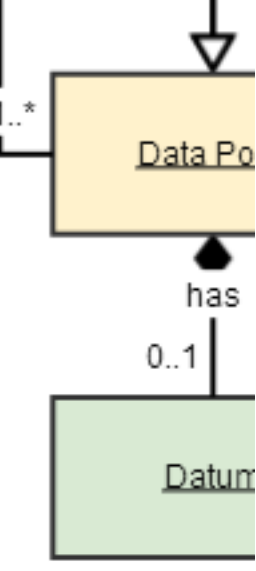

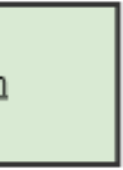
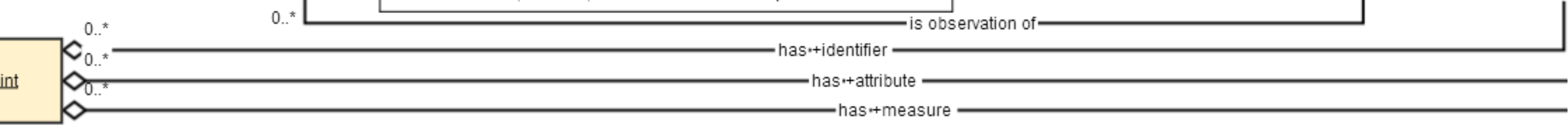

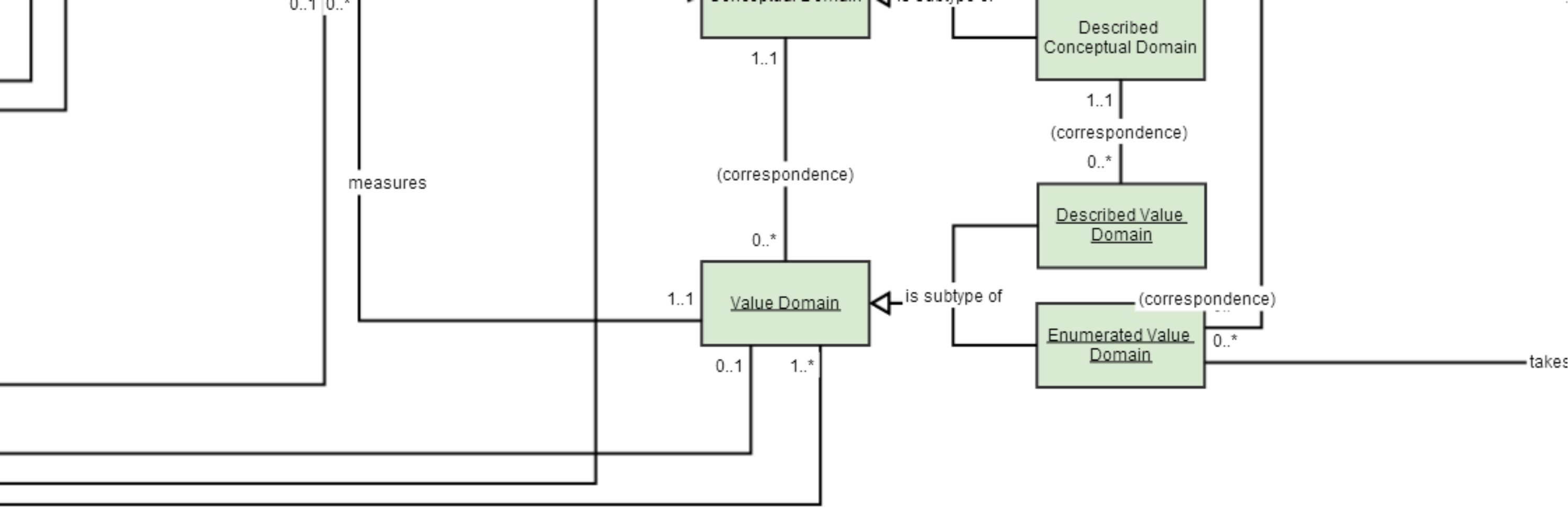

is based on

s values from